

Ø 22/25 mm Selector Switches



S2SR Series CATALOG

For your safety, read and follow the considerations written in the instruction manual, other manuals and Autronics website.

The specifications, dimensions, etc. are subject to change without notice for product improvement. Some Models may be discontinued without notice.

Features

- Smooth operation
- High electrical conductivity
- Long-lasting durability

Safety Considerations

- Observe all 'Safety Considerations' for safe and proper operation to avoid hazards.
- ⚠ symbol indicates caution due to special circumstances in which hazards may occur.





⚠ Warning Failure to follow instructions may result in serious injury or death.





- 01. Fail-safe device must be installed when using the unit with machinery that may cause serious injury or substantial economic loss. (e.g. nuclear power control, medical equipment, ships, vehicles, railways, aircraft, combustion apparatus, safety equipment, crime / disaster prevention devices, etc.)**
Failure to follow this instruction may result in personal injury, economic loss or fire.
- 02. Do not use the unit in the place where flammable / explosive / corrosive gas, high humidity, direct sunlight, radiant heat, vibration, impact, or salinity may be present.**
Failure to follow this instruction may result in explosion or fire.
- 03. Install on a device panel to use.**
Failure to follow this instruction may result in fire or electric shock.
- 04. Do not connect, repair, or inspect the unit while connected to a power source.**
Failure to follow this instruction may result in fire or electric shock.
- 05. Do not disassemble or modify the unit.**
Failure to follow this instruction may result in fire or electric shock.





⚠ Caution Failure to follow instructions may result in injury or product damage.

- 01. This unit shall not be used outdoors.**
Failure to follow this instruction may result in shortening the life cycle of the product or electric shock.
- 02. Use the unit within the rated specifications.**
Failure to follow this instruction may result in fire or product damage.
- 03. Do not use the load beyond rated switching capacity contact.**
Failure to follow this instruction may result in fire, relay broken, contact melt, insulation failure or contact failure.
- 04. For wiring the product, do not pull the wiring excessively or apply excessive force.**
Failure to follow this instruction may result in product damage or malfunction.
- 05. Use dry cloth to clean the unit, and do not use water or organic solvent.**
Failure to follow this instruction may result in fire or electric shock.
- 06. Keep the product away from metal chip, dust, and wire residue which from flowing into the unit.**
Failure to follow this instruction may result in fire or product damage.

Specifications

Series	S2SR Series
Actuation angle	2-position: [Spring return] $60^\circ \pm 5^\circ$, $90^\circ \pm 5^\circ$ [Maintained] $90^\circ \pm 5^\circ$ 3-position: [Spring return] $60^\circ \pm 5^\circ$, $45^\circ \pm 5^\circ$ [Maintained] $90^\circ \pm 5^\circ$, $45^\circ \pm 5^\circ$
Actuation force	0.5 kgf (4.9 N) (per 1 contact)
Installation	Extended
Shock	300 m/s ² (\approx 30 G) in each X, Y, Z direction for 3 times
Shock (malfunction)	100 m/s ² (\approx 10 G) in each X, Y, Z direction for 3 times
Vibration	1.5 mm amplitude at frequency of 10 to 55 Hz (for 1 min) in each X, Y, Z direction for 2 hours
Vibration (malfunction)	1.5 mm amplitude at frequency of 10 to 55 Hz (for 1 min) in each X, Y, Z direction for 10 minutes
Mechanical life cycle (control unit life cycle)	\geq 100,000 operations (20 operations/min)
Ambient temperature	-15 to 55 °C, storage: -25 to 65 °C (no freezing or condensation)
Ambient humidity	35 to 85 %RH, storage: 35 to 85 %RH (no freezing or condensation)
Protection structure	Control unit: IP52 (IEC standard)
Approval	CE    
Control unit weight	Standard head type: \approx 19 g Shark-head type: \approx 16 g
Housing weight	\approx 7 g

Contact blocks	
Power supply / current	110 VAC~ / 10 A, 250 VAC~ / 6 A
Dielectric strength	2,500 VAC~ 50/60 Hz for 1 minute
Insulation resistance	\geq 1,000 M Ω (500 VDC \equiv megger)
Contact resistance	\leq 20 m Ω (initial)
Electrical life cycle	\geq 100,000 operations (20 operations/min)
Contact material	AgNi10
Approval	CE    
Weight	Modular type: \approx 10 g, Singular type: \approx 11 g

LED blocks	
Rated voltage	AC/DC voltage type: 12-24 VAC~ 50/60 Hz, 12-24 VDC \equiv AC voltage type: 110-220 VAC~ 50/60 Hz
Current consumption	\leq 20 mA
Approval	CE    
Weight	AC/DC voltage type: \approx 11 g, AC voltage type: \approx 12 g

Sold Separately

- Contact blocks (SA□-C□□)
- LED blocks (SA□-L□□□)
- Switch enclosures (SA-□B□)
- Locking handle (SA□-LH)
- Switch washer (SA-SW□)

Assembly / Disassembly

- Assembly order: ①→②→③→④
- Disassembly order: a→b→c→④

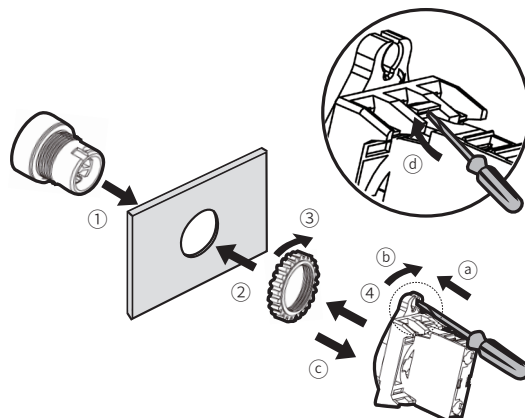

Control Switches	Panel thickness	Tightening torque
Ø 22/25/30 mm	Max. 6 mm	\leq 1.96 N·m

Actuation Angle

■ 2-position spring return (standard lever)

No mark

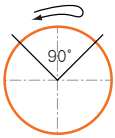

Left 45° - Right 45°

■ 2-position maintained (standard lever)

No mark

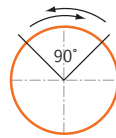

Left 45° - Right 45°

■ 2-position spring return (shark-head lever)

No mark

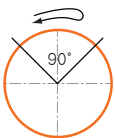

Left 45° - Right 45°

A

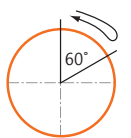

Center 0° - Right 60°

B

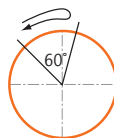

Left 45° - Right 15°

■ 2-position maintained (shark-head lever)

A

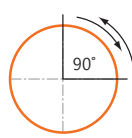

Center 0° - Right 90°

B

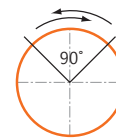

Left 45° - Right 45°

■ 3-position two-way spring return

No mark

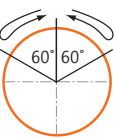

Left 60° - Right 60°

K

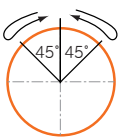

Left 45° - Right 45°

■ 3-position maintained

No mark

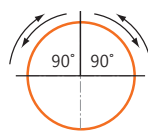

Left 90° - Right 90°

K



Left 45° - Right 45°

■ 3-position right spring return

No mark

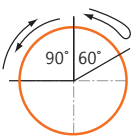

Left 90° - Right 60°

K



Left 45° - Right 45°

■ 3-position left spring return

No mark

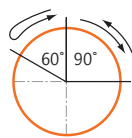

Left 60° - Right 90°

K



Left 45° - Right 45°

Ordering Information

This is only for reference. For selecting the specified Model, follow the Autonics website.

Model is based on control unit+block combination. Control units or blocks are sold separately. In case of block, refer to control switch accessories.

■ Non-illuminated

S2SR	1	-	S	2	3	4	5	6
Control unit							Block	

1 Appearance

No mark: Standard lever

N: Shark-head lever

2 Operation

Short lever	Long lever	Operation
1	2	2-position spring return
3	4	2-position maintained
5	6	3-position two-way spring return
7	8	3-position maintained
A	B	3-position right spring return
C	D	3-position left spring return

3 Actuation angle

Refer to Actuation Angle.

5 Contact block

A: 1 A contact

2A: 2 A contacts

B: 1 B contact

2B: 2 B contacts

AB: 1 A contact, 1 B contact

4 Button color

R: Red

W: White

6 Block

No mark: Singular type

M: Modular type

Model	Contact block		LED block	
	A contact	B contact	AC/DC voltage	AC voltage
S2SR-S1□A(M)	1	-	-	-
S2SR-S1□2A(M)	2	-	-	-
S2SR-S1□B(M)	-	1	-	-
S2SR-S1□2B(M)	-	2	-	-
S2SR-S1□AB(M)	1	1	-	-
S2SR-S3□A(M)	1	-	-	-
S2SR-S3□2A(M)	2	-	-	-
S2SR-S3□B(M)	-	1	-	-
S2SR-S3□2B(M)	-	2	-	-
S2SR-S3□AB(M)	1	1	-	-
S2SR-S5K□2A(M)	2	-	-	-
S2SR-S5K□2B(M)	-	2	-	-
S2SR-S5K□AB(M)	1	1	-	-
S2SR-S7K□2A(M)	2	-	-	-
S2SR-S7K□2B(M)	-	2	-	-
S2SR-S7K□AB(M)	1	1	-	-
S2SR-SAK□2A(M)	2	-	-	-
S2SR-SAK□2B(M)	-	2	-	-
S2SR-SAK□AB(M)	1	1	-	-
S2SR-SCK□2A(M)	2	-	-	-
S2SR-SCK□2B(M)	-	2	-	-
S2SR-SCK□AB(M)	1	1	-	-
S2SR-S5□2A(M)	2	-	-	-
S2SR-S5□2B(M)	-	2	-	-
S2SR-S5□AB(M)	1	1	-	-
S2SR-S7□2A(M)	2	-	-	-
S2SR-S7□2B(M)	-	2	-	-
S2SR-S7□AB(M)	1	1	-	-
S2SR-SA□2A(M)	2	-	-	-
S2SR-SA□2B(M)	-	2	-	-
S2SR-SA□AB(M)	1	1	-	-
S2SR-SC□2A(M)	2	-	-	-
S2SR-SC□2B(M)	-	2	-	-
S2SR-SC□AB(M)	1	1	-	-
S2SR-S2□A(M)	1	-	-	-
S2SR-S2□2A(M)	2	-	-	-
S2SR-S2□B(M)	-	1	-	-
S2SR-S2□2B(M)	-	2	-	-
S2SR-S2□AB(M)	1	1	-	-
S2SR-S4□A(M)	1	-	-	-
S2SR-S4□2A(M)	2	-	-	-
S2SR-S4□B(M)	-	1	-	-
S2SR-S4□2B(M)	-	2	-	-
S2SR-S4□AB(M)	1	1	-	-
S2SR-S6K□2A(M)	2	-	-	-
S2SR-S6K□2B(M)	-	2	-	-
S2SR-S6K□AB(M)	1	1	-	-
S2SR-S8K□2A(M)	2	-	-	-
S2SR-S8K□2B(M)	-	2	-	-
S2SR-S8K□AB(M)	1	1	-	-
S2SR-SBK□2A(M)	2	-	-	-
S2SR-SBK□2B(M)	-	2	-	-
S2SR-SBK□AB(M)	1	1	-	-
S2SR-SDK□2A(M)	2	-	-	-
S2SR-SDK□2B(M)	-	2	-	-
S2SR-SDK□AB(M)	1	1	-	-
S2SR-S6□2A(M)	2	-	-	-
S2SR-S6□2B(M)	-	2	-	-
S2SR-S6□AB(M)	1	1	-	-
S2SR-S8□2A(M)	2	-	-	-
S2SR-S8□2B(M)	-	2	-	-
S2SR-S8□AB(M)	1	1	-	-
S2SR-SB□2A(M)	2	-	-	-
S2SR-SB□2B(M)	-	2	-	-
S2SR-SB□AB(M)	1	1	-	-
S2SR-SD□2A(M)	2	-	-	-
S2SR-SD□2B(M)	-	2	-	-
S2SR-SD□AB(M)	1	1	-	-

Model	Contact block		LED block	
	A contact	B contact	AC/DC voltage	AC voltage
S2SRN-S1A□A(M)	1	-	-	-
S2SRN-S1A□2A(M)	2	-		
S2SRN-S1A□B(M)	-	1		
S2SRN-S1A□2B(M)	-	2		
S2SRN-S1A□AB(M)	1	1	-	-
S2SRN-S3A□A(M)	1	-		
S2SRN-S3A□2A(M)	2	-		
S2SRN-S3A□B(M)	-	1		
S2SRN-S3A□2B(M)	-	2		
S2SRN-S3A□AB(M)	1	1		
S2SRN-S1B□A(M)	1	-		
S2SRN-S1B□2A(M)	2	-		
S2SRN-S1B□B(M)	-	1		
S2SRN-S1B□2B(M)	-	2		
S2SRN-S1B□AB(M)	1	1	-	-
S2SRN-S3B□A(M)	1	-		
S2SRN-S3B□2A(M)	2	-		
S2SRN-S3B□B(M)	-	1		
S2SRN-S3B□2B(M)	-	2		
S2SRN-S3B□AB(M)	1	1		
S2SRN-S1□A(M)	1	-		
S2SRN-S1□2A(M)	2	-		
S2SRN-S1□B(M)	-	1		
S2SRN-S1□2B(M)	-	2		
S2SRN-S1□AB(M)	1	1	-	-
S2SRN-S5K□2A(M)	2	-		
S2SRN-S5K□2B(M)	-	2		
S2SRN-S5K□AB(M)	1	1		
S2SRN-S7K□2A(M)	2	-		
S2SRN-S7K□2B(M)	-	2		
S2SRN-S7K□AB(M)	1	1		
S2SRN-SAK□2A(M)	2	-		
S2SRN-SAK□2B(M)	-	2		
S2SRN-SAK□AB(M)	1	1		
S2SRN-SCK□2A(M)	2	-		
S2SRN-SCK□2B(M)	-	2		
S2SRN-SCK□AB(M)	1	1		
S2SRN-S5□2A(M)	2	-		
S2SRN-S5□2B(M)	-	2		
S2SRN-S5□AB(M)	1	1		
S2SRN-S7□2A(M)	2	-		
S2SRN-S7□2B(M)	-	2		
S2SRN-S7□AB(M)	1	1		
S2SRN-SA□2A(M)	2	-		
S2SRN-SA□2B(M)	-	2		
S2SRN-SA□AB(M)	1	1		
S2SRN-SC□2A(M)	2	-		
S2SRN-SC□2B(M)	-	2		
S2SRN-SC□AB(M)	1	1		
S2SRN-S2A□A(M)	1	-		
S2SRN-S2A□2A(M)	2	-		
S2SRN-S2A□B(M)	-	1		
S2SRN-S2A□2B(M)	-	2		
S2SRN-S2A□AB(M)	1	1		
S2SRN-S4A□A(M)	1	-		
S2SRN-S4A□2A(M)	2	-		
S2SRN-S4A□B(M)	-	1		
S2SRN-S4A□2B(M)	-	2		
S2SRN-S4A□AB(M)	1	1		
S2SRN-S2B□A(M)	1	-		
S2SRN-S2B□2A(M)	2	-		
S2SRN-S2B□B(M)	-	1		
S2SRN-S2B□2B(M)	-	2		
S2SRN-S2B□AB(M)	1	1		
S2SRN-S4B□A(M)	1	-		
S2SRN-S4B□2A(M)	2	-		
S2SRN-S4B□B(M)	-	1		
S2SRN-S4B□2B(M)	-	2		
S2SRN-S4B□AB(M)	1	1		
S2SRN-S2□A(M)	1	-		
S2SRN-S2□2A(M)	2	-		
S2SRN-S2□B(M)	-	1		
S2SRN-S2□2B(M)	-	2		
S2SRN-S2□AB(M)	1	1		

Model	Contact block		LED block	
	A contact	B contact	AC/DC voltage	AC voltage
S2SRN-S6K□2A(M)	2	-	-	-
S2SRN-S6K□2B(M)	-	2		
S2SRN-S6K□AB(M)	1	1		
S2SRN-S8K□2A(M)	2	-	-	-
S2SRN-S8K□2B(M)	-	2		
S2SRN-S8K□AB(M)	1	1		
S2SRN-SBK□2A(M)	2	-		
S2SRN-SBK□2B(M)	-	2	-	-
S2SRN-SBK□AB(M)	1	1		
S2SRN-SDK□2A(M)	2	-		
S2SRN-SDK□2B(M)	-	2		
S2SRN-SDK□AB(M)	1	1		
S2SRN-S6□2A(M)	2	-		
S2SRN-S6□2B(M)	-	2		
S2SRN-S6□AB(M)	1	1		
S2SRN-S8□2A(M)	2	-		
S2SRN-S8□2B(M)	-	2		
S2SRN-S8□AB(M)	1	1		
S2SRN-SB□2A(M)	2	-		
S2SRN-SB□2B(M)	-	2		
S2SRN-SB□AB(M)	1	1		
S2SRN-SD□2A(M)	2	-		
S2SRN-SD□2B(M)	-	2		
S2SRN-SD□AB(M)	1	1		

■ Illuminated

S2SR N - L ① ② ③			④ ⑤ ⑥		
Control unit			Block		

① Operation

Short lever	Long lever	Operation
1	2	2-position spring return
3	4	2-position maintained
5	6	3-position two-way spring return
7	8	3-position maintained
A	B	3-position right spring return
C	D	3-position left spring return

② Actuation angle

Refer to Actuation Angle.

④ Contact block

A: 1 A contact
 2A: 2 A contacts
 B: 1 B contact
 2B: 2 B contacts
 AB: 1 A contact, 1 B contact

③ Button color

R: Red
 B: Blue
 G: Green
 Y: Yellow

⑤ LED block

D: 1 AC/DC voltage type
 L: 1 AC voltage type

⑥ Block

No mark: Singular type
 M: Modular type

Model	Contact block		LED block	
	A contact	B contact	AC/DC voltage	AC voltage
S2SRN-L1A□AL(M)	1	-		
S2SRN-L1A□2AL(M)	2	-		
S2SRN-L1A□BL(M)	-	1	-	1
S2SRN-L1A□2BL(M)	-	2		
S2SRN-L1A□ABL(M)	1	1		
S2SRN-L3A□AL(M)	1	-		
S2SRN-L3A□2AL(M)	2	-	-	1
S2SRN-L3A□BL(M)	-	1		
S2SRN-L3A□2BL(M)	-	2		
S2SRN-L3A□ABL(M)	1	1		
S2SRN-L1B□AL(M)	1	-		
S2SRN-L1B□2AL(M)	2	-		
S2SRN-L1B□BL(M)	-	1	-	1
S2SRN-L1B□2BL(M)	-	2		
S2SRN-L1B□ABL(M)	1	1		
S2SRN-L3B□AL(M)	1	-		
S2SRN-L3B□2AL(M)	2	-	-	1
S2SRN-L3B□BL(M)	-	1		
S2SRN-L3B□2BL(M)	-	2		
S2SRN-L3B□ABL(M)	1	1		
S2SRN-L1□AL(M)	1	-		
S2SRN-L1□2AL(M)	2	-		
S2SRN-L1□BL(M)	-	1	-	1
S2SRN-L1□2BL(M)	-	2		
S2SRN-L1□ABL(M)	1	1		
S2SRN-L5K□2AL(M)	2	-		
S2SRN-L5K□2BL(M)	-	2	-	1
S2SRN-L5K□ABL(M)	1	1		
S2SRN-L7K□2AL(M)	2	-		
S2SRN-L7K□2BL(M)	-	2	-	1
S2SRN-L7K□ABL(M)	1	1		
S2SRN-LAK□2AL(M)	2	-		
S2SRN-LAK□2BL(M)	-	2	-	1
S2SRN-LAK□ABL(M)	1	1		
S2SRN-LCK□2AL(M)	2	-		
S2SRN-LCK□2BL(M)	-	2	-	1
S2SRN-LCK□ABL(M)	1	1		
S2SRN-L5□2AL(M)	2	-		
S2SRN-L5□2BL(M)	-	2	-	1
S2SRN-L5□ABL(M)	1	1		
S2SRN-L7□2AL(M)	2	-		
S2SRN-L7□2BL(M)	-	2	-	1
S2SRN-L7□ABL(M)	1	1		
S2SRN-LA□2AL(M)	2	-		
S2SRN-LA□2BL(M)	-	2	-	1
S2SRN-LA□ABL(M)	1	1		
S2SRN-LC□2AL(M)	2	-		
S2SRN-LC□2BL(M)	-	2	-	1
S2SRN-LC□ABL(M)	1	1		
S2SRN-L1A□AD(M)	1	-		
S2SRN-L1A□2AD(M)	2	-		
S2SRN-L1A□BD(M)	-	1	1	-
S2SRN-L1A□2BD(M)	-	2		
S2SRN-L1A□ABD(M)	1	1		
S2SRN-L3A□AD(M)	1	-		
S2SRN-L3A□2AD(M)	2	-		
S2SRN-L3A□BD(M)	-	1	1	-
S2SRN-L3A□2BD(M)	-	2		
S2SRN-L3A□ABD(M)	1	1		
S2SRN-L1B□AD(M)	1	-		
S2SRN-L1B□2AD(M)	2	-		
S2SRN-L1B□BD(M)	-	1	1	-
S2SRN-L1B□2BD(M)	-	2		
S2SRN-L1B□ABD(M)	1	1		
S2SRN-L3B□AD(M)	1	-		
S2SRN-L3B□2AD(M)	2	-		
S2SRN-L3B□BD(M)	-	1	1	-
S2SRN-L3B□2BD(M)	-	2		
S2SRN-L3B□ABD(M)	1	1		
S2SRN-L1□AD(M)	1	-		
S2SRN-L1□2AD(M)	2	-		
S2SRN-L1□BD(M)	-	1	1	-
S2SRN-L1□2BD(M)	-	2		
S2SRN-L1□ABD(M)	1	1		

Model	Contact block		LED block	
	A contact	B contact	AC/DC voltage	AC voltage
S2SRN-L5K□2AD(M)	2	-	1	-
S2SRN-L5K□2BD(M)	-	2		
S2SRN-L5K□ABD(M)	1	1		
S2SRN-L7K□2AD(M)	2	-	1	-
S2SRN-L7K□2BD(M)	-	2		
S2SRN-L7K□ABD(M)	1	1		
S2SRN-LAK□2AD(M)	2	-	1	-
S2SRN-LAK□2BD(M)	-	2		
S2SRN-LAK□ABD(M)	1	1		
S2SRN-LCK□2AD(M)	2	-	1	-
S2SRN-LCK□2BD(M)	-	2		
S2SRN-LCK□ABD(M)	1	1		
S2SRN-L5□2AD(M)	2	-	1	-
S2SRN-L5□2BD(M)	-	2		
S2SRN-L5□ABD(M)	1	1		
S2SRN-L7□2AD(M)	2	-	1	-
S2SRN-L7□2BD(M)	-	2		
S2SRN-L7□ABD(M)	1	1		
S2SRN-LA□2AD(M)	2	-	1	-
S2SRN-LA□2BD(M)	-	2		
S2SRN-LA□ABD(M)	1	1		
S2SRN-LC□2AD(M)	2	-	1	-
S2SRN-LC□2BD(M)	-	2		
S2SRN-LC□ABD(M)	1	1		
S2SRN-L2A□AL(M)	1	-	-	1
S2SRN-L2A□2AL(M)	2	-		
S2SRN-L2A□BL(M)	-	1		
S2SRN-L2A□2BL(M)	-	2	-	1
S2SRN-L2A□ABL(M)	1	1		
S2SRN-L4A□AL(M)	1	-		
S2SRN-L4A□2AL(M)	2	-	-	1
S2SRN-L4A□BL(M)	-	1		
S2SRN-L4A□2BL(M)	-	2		
S2SRN-L4A□ABL(M)	1	1	-	1
S2SRN-L2B□AL(M)	1	-		
S2SRN-L2B□2AL(M)	2	-		
S2SRN-L2B□BL(M)	-	1	-	1
S2SRN-L2B□2BL(M)	-	2		
S2SRN-L2B□ABL(M)	1	1		
S2SRN-L4B□AL(M)	1	-	-	1
S2SRN-L4B□2AL(M)	2	-		
S2SRN-L4B□BL(M)	-	1		
S2SRN-L4B□2BL(M)	-	2	-	1
S2SRN-L4B□ABL(M)	1	1		
S2SRN-L2□AL(M)	1	-		
S2SRN-L2□2AL(M)	2	-	-	1
S2SRN-L2□BL(M)	-	1		
S2SRN-L2□2BL(M)	-	2		
S2SRN-L2□ABL(M)	1	1	-	1
S2SRN-L6K□2AL(M)	2	-		
S2SRN-L6K□2BL(M)	-	2		
S2SRN-L6K□ABL(M)	1	1	-	1
S2SRN-L8K□2AL(M)	2	-		
S2SRN-L8K□2BL(M)	-	2		
S2SRN-L8K□ABL(M)	1	1	-	1
S2SRN-LBK□2AL(M)	2	-		
S2SRN-LBK□2BL(M)	-	2		
S2SRN-LBK□ABL(M)	1	1	-	1
S2SRN-LDK□2AL(M)	2	-		
S2SRN-LDK□2BL(M)	-	2		
S2SRN-LDK□ABL(M)	1	1	-	1
S2SRN-L6□2AL(M)	2	-		
S2SRN-L6□2BL(M)	-	2		
S2SRN-L6□ABL(M)	1	1	-	1
S2SRN-L8□2AL(M)	2	-		
S2SRN-L8□2BL(M)	-	2		
S2SRN-L8□ABL(M)	1	1	-	1
S2SRN-LB□2AL(M)	2	-		
S2SRN-LB□2BL(M)	-	2		
S2SRN-LB□ABL(M)	1	1	-	1
S2SRN-LD□2AL(M)	2	-		
S2SRN-LD□2BL(M)	-	2		
S2SRN-LD□ABL(M)	1	1	-	1

Model	Contact block		LED block	
	A contact	B contact	AC/DC voltage	AC voltage
S2SRN-L2A□AD(M)	1	-	1	-
S2SRN-L2A□2AD(M)	2	-		
S2SRN-L2A□BD(M)	-	1		
S2SRN-L2A□2BD(M)	-	2	1	-
S2SRN-L2A□ABD(M)	1	1		
S2SRN-L4A□AD(M)	1	-		
S2SRN-L4A□2AD(M)	2	-	1	-
S2SRN-L4A□BD(M)	-	1		
S2SRN-L4A□2BD(M)	-	2		
S2SRN-L4A□ABD(M)	1	1	1	-
S2SRN-L2B□AD(M)	1	-		
S2SRN-L2B□BD(M)	-	1		
S2SRN-L2B□2BD(M)	-	2	1	-
S2SRN-L2B□ABD(M)	1	1		
S2SRN-L4B□AD(M)	1	-		
S2SRN-L4B□2AD(M)	2	-	1	-
S2SRN-L4B□BD(M)	-	1		
S2SRN-L4B□2BD(M)	-	2		
S2SRN-L4B□ABD(M)	1	1	1	-
S2SRN-L2□AD(M)	1	-		
S2SRN-L2□2AD(M)	2	-		
S2SRN-L2□BD(M)	-	1	1	-
S2SRN-L2□2BD(M)	-	2		
S2SRN-L2□ABD(M)	1	1		
S2SRN-L6K□2AD(M)	2	-	1	-
S2SRN-L6K□2BD(M)	-	2		
S2SRN-L6K□ABD(M)	1	1		
S2SRN-L8K□2AD(M)	2	-	1	-
S2SRN-L8K□2BD(M)	-	2		
S2SRN-L8K□ABD(M)	1	1		
S2SRN-LBK□2AD(M)	2	-	1	-
S2SRN-LBK□2BD(M)	-	2		
S2SRN-LBK□ABD(M)	1	1		
S2SRN-LDK□2AD(M)	2	-	1	-
S2SRN-LDK□2BD(M)	-	2		
S2SRN-LDK□ABD(M)	1	1		
S2SRN-L6□2AD(M)	2	-	1	-
S2SRN-L6□2BD(M)	-	2		
S2SRN-L6□ABD(M)	1	1		
S2SRN-L8□2AD(M)	2	-	1	-
S2SRN-L8□2BD(M)	-	2		
S2SRN-L8□ABD(M)	1	1		
S2SRN-LB□2AD(M)	2	-	1	-
S2SRN-LB□2BD(M)	-	2		
S2SRN-LB□ABD(M)	1	1		
S2SRN-LD□2AD(M)	2	-	1	-
S2SRN-LD□2BD(M)	-	2		
S2SRN-LD□ABD(M)	1	1		

Dimensions

- Unit: mm, For the detailed drawings, follow the Autonics website.
- Panel thickness: ≤ 6 mm

■ S2SR-S1/3/5/7/A/C □ (standard / short lever, singular type block)

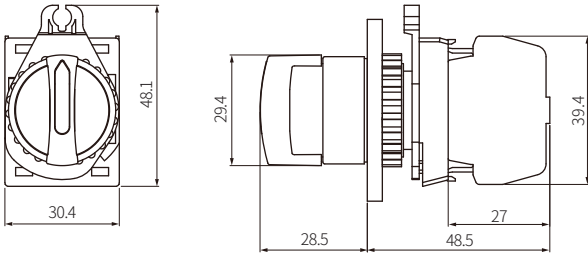

■ S2SR-S1/3/5/7/A/C □ M (standard / short lever, modular type block)

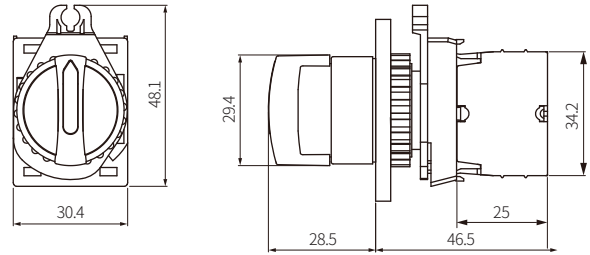

■ S2SR-S2/4/6/8/B/D □ (standard / long lever, singular type block)

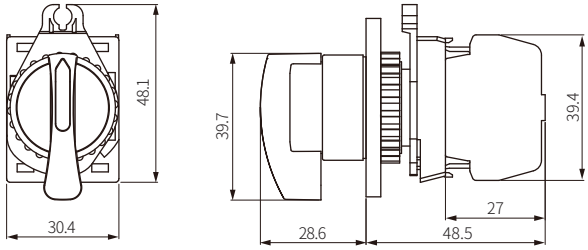

■ S2SR-S2/4/6/8/B/D □ M (standard / long lever, modular type block)

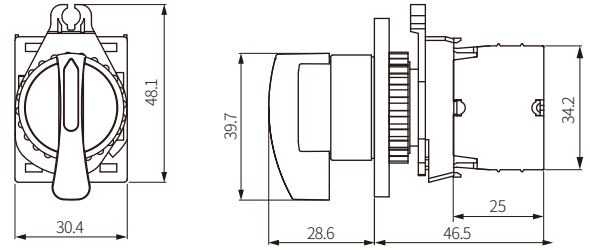

■ S2SRN-□1/3/5/7/A/C □ (shark-head / short lever, singular type block)

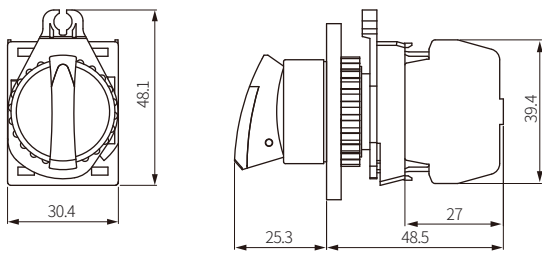

■ S2SRN-□1/3/5/7/A/C □ M (shark-head / short lever, modular type block)

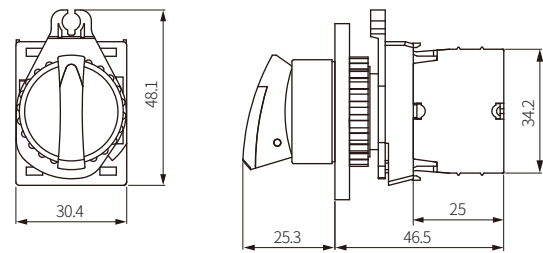

■ S2SRN-□2/4/6/8/B/D □ (shark-head / long lever, singular type block)

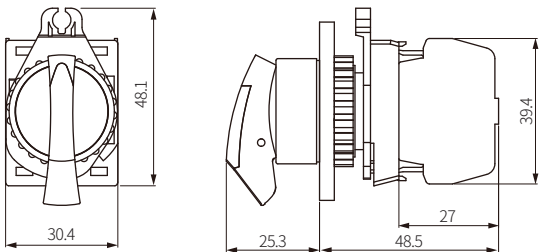

■ S2SRN-□2/4/6/8/B/D □ M (shark-head / long lever, modular type block)

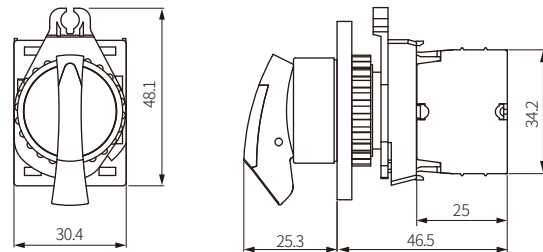

■ Panel cut-out

<Mounting round: Ø 25>

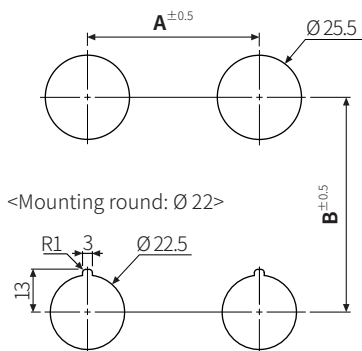

	A	B
Short lever	≥ 33	≥ 55
Long lever	≥ 55	≥ 55